

A GPS DISCIPLINED RUBIDIUM CLOCK

Wayne Dewey
Kinematics/TrueTime
3243 Santa Rosa Ave.
Santa Rosa, CA 95407

Abstract

Sub-microsecond timing accuracy for event tagging and multi-site synchronization is possible using the Global Positioning System. In order to maintain a high degree of accuracy during periods when no satellites are visible, a highly stable local time base is required. For those cases which require Cesium oscillator stability, initial cost and continuing maintenance of the Cesium oscillator must be considered. A viable alternative is to use the Global Positioning System and an oscillator disciplining process. With this system, near Cesium performance can be achieved using a more rugged lower cost Rubidium oscillator. Additionally, when 24 hour satellite coverage becomes available, system performance may surpass that of a Cesium in long term stability.

INTRODUCTION

In recent years, time synchronization requirements between remote sites has become more demanding in terms of accuracy and stability. Power utilities are now looking to synchronize sites to under one microsecond to allow a means of maintaining grid stability while increasing power flow, and to time-tag power disturbances for location and analysis. Increasing demands for synchronous telecommunications requires both precise time and a stable frequency source at all sites.

The Global Positioning System (GPS) presently offers the means to satisfy sub-microsecond timing requirements worldwide on a daily basis. Additionally, while the short term stability of the GPS is fair, the long term stability of the GPS is excellent and approaches the stability of the UTC time source for GPS.

Is it possible to instill the long term stability characteristics of GPS into a low cost local oscillator which has good short term stability, thus satisfying both inter-site timing and local stability requirements with one system? In order to do so, all long term drift and aging characteristics of the Rubidium must be removed without disturbing the short and medium term stability of the oscillator. Additionally, long term frequency accuracy must be improved while maintaining accurate time.

This paper presents the results achieved when a local Rubidium oscillator is disciplined to GPS. Two control algorithms were tested, one controlling for zero frequency error and one for zero time error. The results of each are presented.

THE COMPONENTS

Both of the algorithms tested are designed to remove aging and long term drift components of the Rubidium oscillator while maintaining an accurate frequency. The first algorithm, Time and Rate

control, is an order 2, type 2 Phase Locked Loop which controls the Rubidium for zero time (or phase) error. This loop is designed to minimize the integral of frequency error over long term. The second algorithm, Rate control, is a Frequency Locked Loop which controls for zero frequency error. Both algorithms remove accumulated 1 Hz time error once per day.

THE UNIT UNDER TEST is a GPS-based Digital Clock (GPS-DC) with integral GPS time receiver and miniature Disciplined Rubidium oscillator. The Rubidium oscillator serves as the local time base for both the GPS-DC clock electronics and the GPS receiver. The GPS-DC has a specified accuracy of 100 ns to GPS and 250 ns to UTC(USNO) when tracking satellites.

THE GLOBAL POSITIONING SYSTEM is the standard upon which the disciplining process is based, and as such must be accurate and stable. Timing accuracy of GPS to UTC(USNO) is specified at 150 ns but has been reported to be as low as 35 ns^[5,9]. The long term stability of GPS is shown in Figure 1, which is the Allan Variance of GPS time transfer stability. Note with a 16 day τ or sample period, the frequency stability $\sigma_y(\tau)$ is 1.9×10^{-14} ^[1].

THE GPS RECEIVER is a Rockwell Collins Navcore I receiver. The receiver has a basic timing accuracy of 100 ns to GPS time and 250 us to UTC(USNO) time when the receiver's antenna position is known within 25 meters^[4,5]. The GPS receiver outputs information in the forms of a 1 Hz on-time pulse and various serial data. Among the serial information outputted is the variable Range Bias, used in the disciplining process. With the GPS receiver placed in position hold mode, Range Bias effectively represents the difference between the GPS receiver's local internal time and GPS time in units of meters, directly translatable into seconds of error. Because the GPS receiver's local time base is the Rubidium oscillator, any medium to long term changes in Range Bias are directly attributable to changes in the Rubidium oscillator. Range Bias has a usable resolution of a few nanoseconds.

THE DISCIPLINED RUBIDIUM OSCILLATOR is an FRS-C Miniature Rubidium Oscillator manufactured by Ball-Efratom. The oscillator has a C-field electrical tuning input which allows an adjustment range of 7.5×10^{-10} over 5 volts. The present FRS-C specifications (which will be improved) include a frequency stability of 5.0×10^{-11} per month and 2.0×10^{-10} per year. The frequency accuracy specification is 1.0×10^{-9} per year. The temperature specification for this oscillator is 3.0×10^{-10} from -5 to +55 degrees C. and is not linear over the range. By limiting changes in ambient temperature to ± 3 degrees and applying temperature compensation directly to the Rubidium oscillator, the effects of ambient temperature fluctuations are minimized.

A block diagram of the disciplining process is shown in Figure 2. The Rubidium oscillator is used as the primary local time base for both the clock and the GPS receiver. The GPS-DC averages 2,048 seconds of Range Bias values into a single datum once per day. In conjunction with the previous day's datum, the oscillator's average frequency error for the previous 24 hour period is calculated. The clock then calculates the required disciplining voltage correction, sums the result with the temperature compensating voltage for the oscillator, and applies the resulting disciplining voltage to the Rubidium oscillator.

THE TEST CONFIGURATION, shown in Figure 3, was designed to allow cross-checking of acquired data, assuring unambiguous identification of error sources. All critical parameters were acquired using the data acquisition system. This system consists of a 16 channel 12 bit Analog to Digital subsystem and an RS-232C data acquisition program running concurrently within a PC-AT clone. Approximately 1.2 Mbytes of data was accumulated per week using this system.

Cesium to Rubidium timing performance was monitored using the clock's Time Interval input with 100 ns resolution. Performance was also monitored using an analog phase comparison of Cesium 5 Mhz

and Rubidium 10 Mhz (both divided to 1 Mhz) with an effective resolution of 2 ns. This information was used to compare time and frequency stability over a range of 100 seconds to 40,000 seconds.

The Loran-C 1 Hz and GPS receiver 1 Hz comparison was used as an aid in initial system setup and to monitor GPS and receiver time error events during the test.

Rubidium disciplining voltage and baseplate temperature were acquired via analog channels for monitoring purposes.

TEST RESULTS

First to be examined is the Rubidium medium term stability (under one day) characteristic which is measured using the Cesium oscillator. Figure 4 shows the Allan Variance between the Rubidium and the Cesium oscillators. As can be seen by the plot, the oscillators are well behaved, reaching a low of 2.5×10^{-13} at a τ of 20,000 seconds. Both control algorithms exhibit the same performance for sample periods of less than one day.

Figure 5 is the same Allan Variance plot now extended out to 5 days with GPS data obtained using the Time and Rate control algorithm. A peak of 1.2×10^{-12} is seen at a τ of 2 days, caused by the disciplining process. The upper (+) plot represents the undisciplined Allan Variance plot of an FRS-C Rubidium oscillator. The upward trend representing long term drift and aging of the oscillator is not present in the disciplined oscillator Allan Variance plot.

Figure 6 is an Allan Variance plot of the Rate control algorithm. Note the consistent trend downwards until again the disciplining process brings the stability up to a 1.2×10^{-12} peak, this time at a τ or sample average of 1 day. Afterwards the graph peaks again at 3 days at 7.0×10^{-13} due to the cyclic effects of the disciplining process. Again note the elimination of long term drift and aging of the oscillator.

The daily frequency error for the Disciplined Rubidium using Rate control can be seen in Figure 7. A weekly cyclical frequency error between GPS and the Rubidium can be seen in this plot. It is unclear as to why this cyclical error exists, but it is evidently in the Rubidium oscillator and disciplining process as Figure 8 shows the same cyclic error when the Rubidium is compared to the Cesium. A possible reason could be the response characteristic of the Rubidium to small control voltage changes. The average frequency error offset of this algorithm is 1.2×10^{-12} and the peak error is 2.2×10^{-12} .

With the frequency offset and stability performance above, Figure 9 shows the peak daily time error of the Rubidium when time error is removed once per day. The maximum daily peak error measured was 180 ns to the GPS receiver. For smaller time errors, the error removal process could be performed more frequently.

Figure 10 is a graph of daily frequency accuracy of the Time and Rate control algorithm with respect to GPS. The maximum daily averaged frequency error seen is 3.0×10^{-12} , and, because of the Time control component of the algorithm, the frequency error is centered about zero. The large full cycle transient seen beginning at MJD 47,771 was initiated by a random walk frequency modulation process. The control algorithm required 2 days to remove the step, then proceeded to reverse the effects of the step on time accumulation with an equal transient in the positive direction. This algorithm was initially designed for applications prohibiting the use of microstepping in the 1 Hz output.

Timing accuracy of the Time and Rate control algorithm can be seen in Figure 11. Again, time error is allowed to accumulate for a 24 hour period before removal. The time error peaks are shown in this

plot and do not exceed 250 ns with respect to the GPS receiver.

CONCLUSIONS

Timing Accuracy

Timing accuracy of the GPS-DC clock when corrected daily was 250 ns to the GPS receiver and 500 ns to UTC(USNO). By removing time error more frequently than the once per day period used for these tests, error to UTC(USNO) would be reduced to 250 ns plus the error of the time error removal scheme.

Frequency Accuracy

Frequency accuracy for the Disciplined Rubidium oscillator was improved from 1.0×10^{-9} per year to 3.0×10^{-12} for Time and Rate control and 2.2×10^{-12} for Rate control. As all effects of aging and long term drift have been removed, these values are now constant.

Frequency Stability

Long term frequency stability achieved with this oscillator was 1.0×10^{-12} with Rate control and 3.0×10^{-12} with Time and Rate control. The Rate control algorithm also shows a trend towards better long term stability, achieving 3.0×10^{-13} at 5 days (Figure 9). Aging and long term drift effects have been removed through the disciplining process. Short term frequency stability was not affected.

TABLE I		
	Frequency Accuracy	Frequency Stability
CESIUM ^[2,7] (typical performance)	3.0×10^{-12} 3.0×10^{-13}	2.0×10^{-12} (over Cs tube life) 2.0×10^{-13} @ 1 day 7.0×10^{-14} @ 10 days)
RUBIDIUM DISCIPLINED WITH TIME AND RATE CONTROL	3.0×10^{-12}	2.5×10^{-12} (@ 1 day) 1.0×10^{-12} (@ 5 days)
RUBIDIUM DISCIPLINED WITH RATE CONTROL	2.2×10^{-12}	1.0×10^{-12} (@ 1 day) 3.0×10^{-13} (@ 5 days)

The Rubidium oscillator's long term drift specifications of 5.0×10^{-11} per month and 5.0×10^{-10} per year have effectively been reduced to the long term drift of UTC(USNO), the time source for the GPS system.

A direct comparison of Cesium oscillator frequency accuracy and stability specifications to results obtained with the Rubidium Disciplining process is summarized in Table 1.

This test has shown that a local Rubidium oscillator disciplined to GPS can approach the long term stability and frequency accuracy of a Cesium oscillator, with the added advantage of offering time traceable to UTC(USNO). Performance may be improved by disciplining an oscillator with better stability specifications, and by reducing the control sample period.

APPENDIX

A word on algorithm development:

The Time and Rate control algorithm was designed to address the following basic clock mathematical model:

$$x(t) = x_0 + y_0t + \frac{1}{2}Dt^2 + \epsilon(t) \quad [6] \quad (1)$$

Where $x(t)$ is the time error of the clock at time t , x_0 is the initial synchronization error at $t = 0$, y_0 is the initial frequency offset at $t = 0$ (synchronization error), D is the frequency drift term and $\epsilon(t)$ represents all random fluctuations of the clock.

The Time and Rate control algorithm responds to the first 2 terms of the equation with zero error and can effectively remove them. The algorithm responds to the third term, Dt^2 with a constant time error, the magnitude proportional to D , the 2nd derivative of this third term. For the fourth and last term, $\epsilon(t)$, the algorithm will minimize the effects of Random Walk of Frequency on time error over the long term by forcing an artificial and opposite Random Walk event. Frequency stability in the range of 1 to 3 days is degraded using this method. In summing up the response to Equation 1, the Time and Rate control algorithm will exhibit zero frequency error and a small, constant timing error.

The Rate control algorithm is a frequency locked loop and is designed according to Equation 2:

$$y(t) = y_0 + Dt + \epsilon(t) \quad (2)$$

Where $y(t)$ is the frequency error of the clock source at time t , y_0 is the initial frequency error at $t = 0$, D is again the long term drift of the clock source, and $\epsilon(t)$ represents the random fluctuations of the clock. The algorithm will respond to Equation 2 with a small frequency error proportional to the derivative of the second term, D , and will minimize Random Walk FM contained within $\epsilon(t)$. In summing up the response to Equation 2, the Rate control algorithm will minimize frequency instability and will exhibit a small constant frequency offset.

REFERENCES

1. Weiss, Mark A. and Allan, David W. "The NBS Calibration Procedure for Providing Time and Frequency at a Remote Site by Weighting and Smoothing of GPS Common View Data", National Institute of Standards and Technology, Time and Frequency Division.
2. Hellwig, H. "Frequency Standards and Clocks: A Tutorial Introduction", U.S. Department of Commerce / National Institute of Standards and Technology Technical Note # 616, 2nd Revision.

3. Allan, David W. "Time and Frequency (Time-Domain) Characterization, Estimation, and Prediction of Precision Clocks and Oscillators" IEEE Transactions on Ultrasonics, Ferroelectrics, and Frequency Control Volume UFFC-34, No. 6, November 1987.
4. Knoernschild, G.F. "Global Positioning System for Time and Frequency Measurements" Proceedings of the Nineteenth Annual Precise Time and Time Interval (PTTI) Applications and Planning Meeting, December 1-3, 1987.
5. Global Positioning System Joint Program Office, ICD-GPS-200 Navstar GPS Space Segment, Navigation User Interfaces.
6. Allan, David W. Clock Characterization Tutorial, NIST Time and Frequency Seminar, June 5, 6, 7 1989.
7. Precision Time and Frequency Handbook, Ball Corporation, Efratom Division, Sixth Edition, 1987.
8. Weiss, Mark "Design of Kalman Smoothers in GPS Data", IEEE Instrumentation and Measurement Society, April 1989 Vol. 38 #2 p 652.
9. USNO Automatic Data System, GPS Time Transfer Information, @GPSAC.

GPS TIME TRANSFER

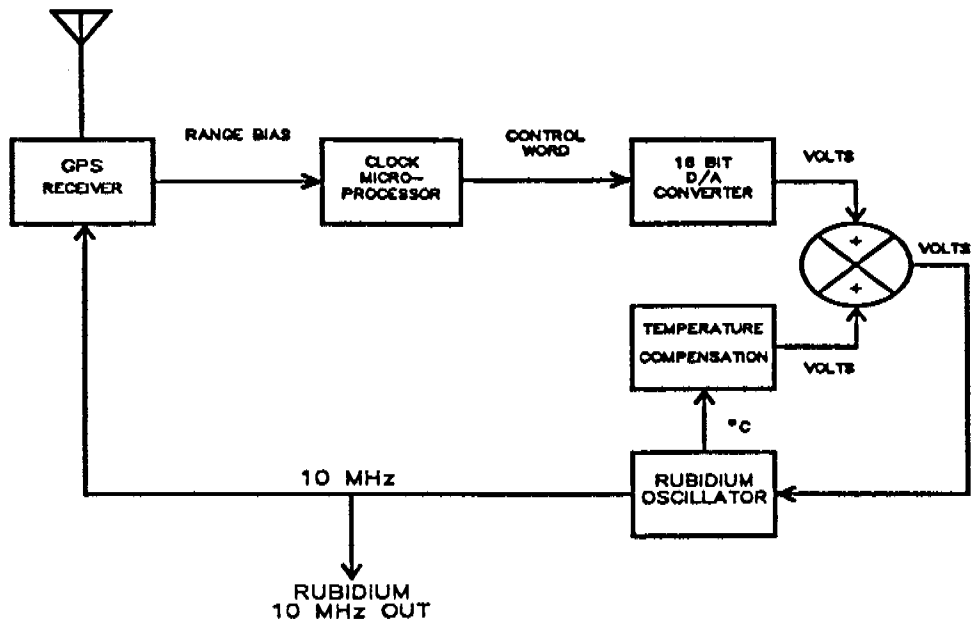
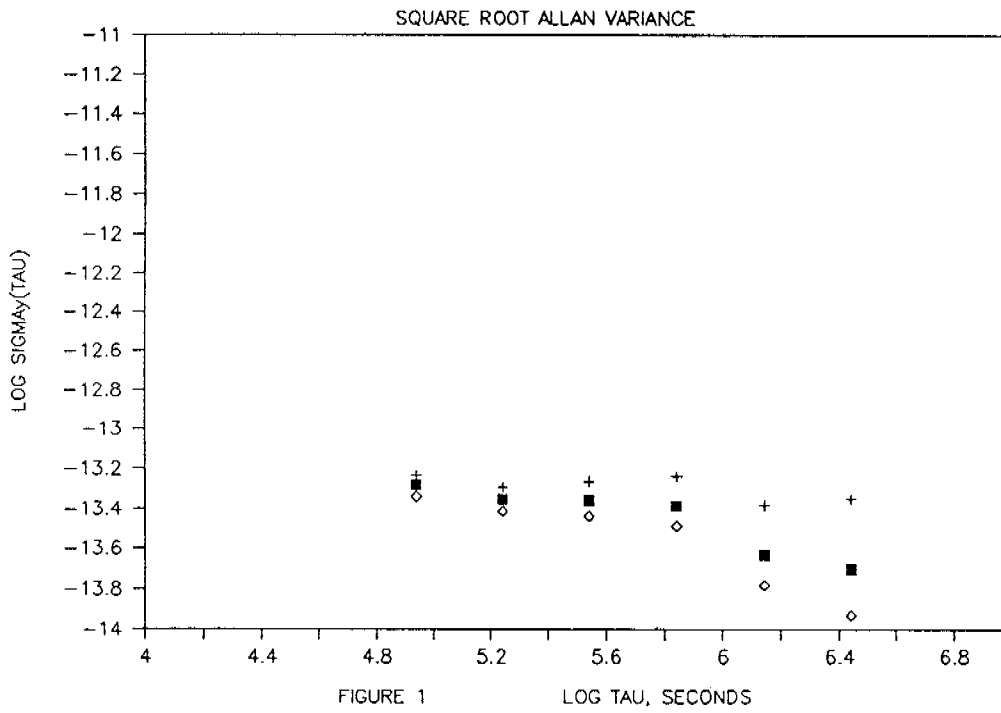

FIGURE 2 DISCIPLINED RUBIDIUM CONTROL LOOP

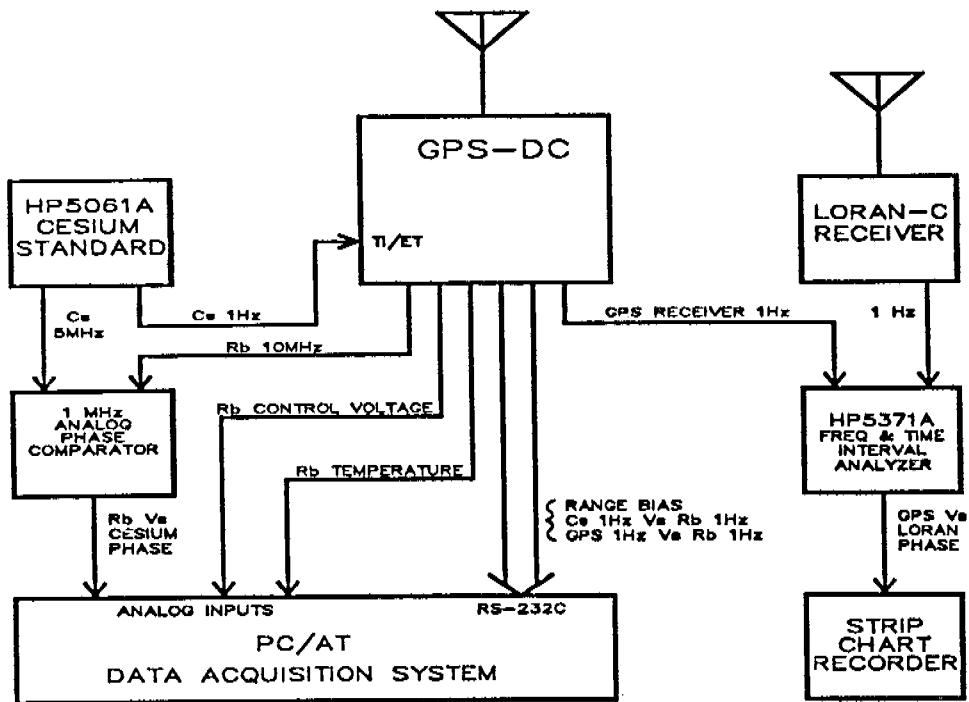

FIGURE 3 DISCIPLINED RUBIDIUM TEST CONFIGURATION

RUBIDIUM VS CESIUM

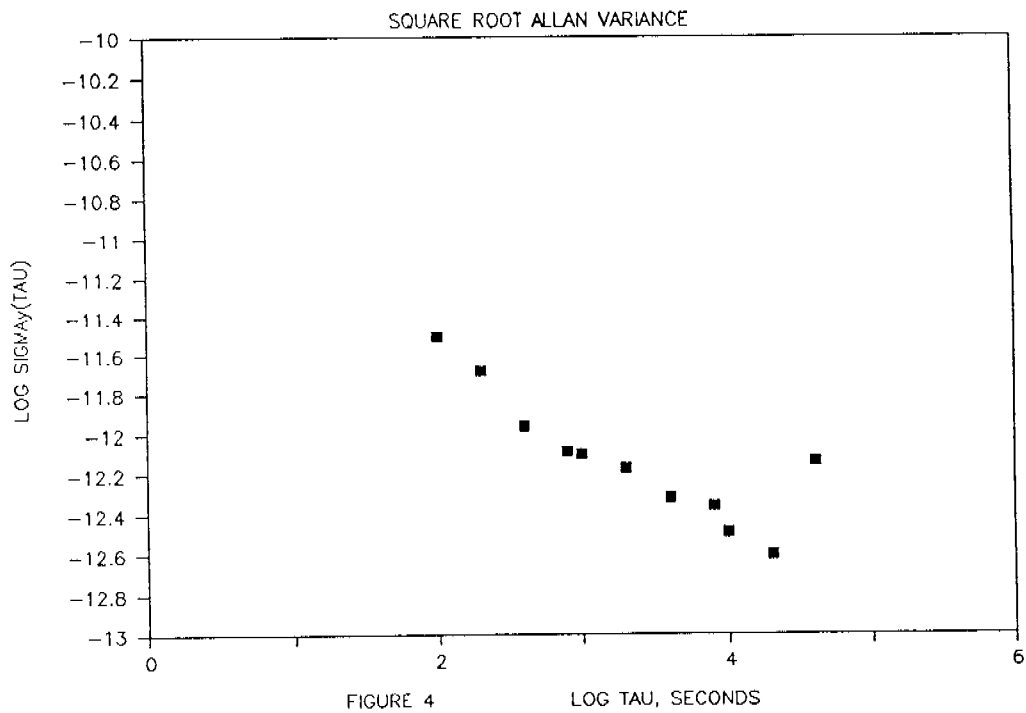
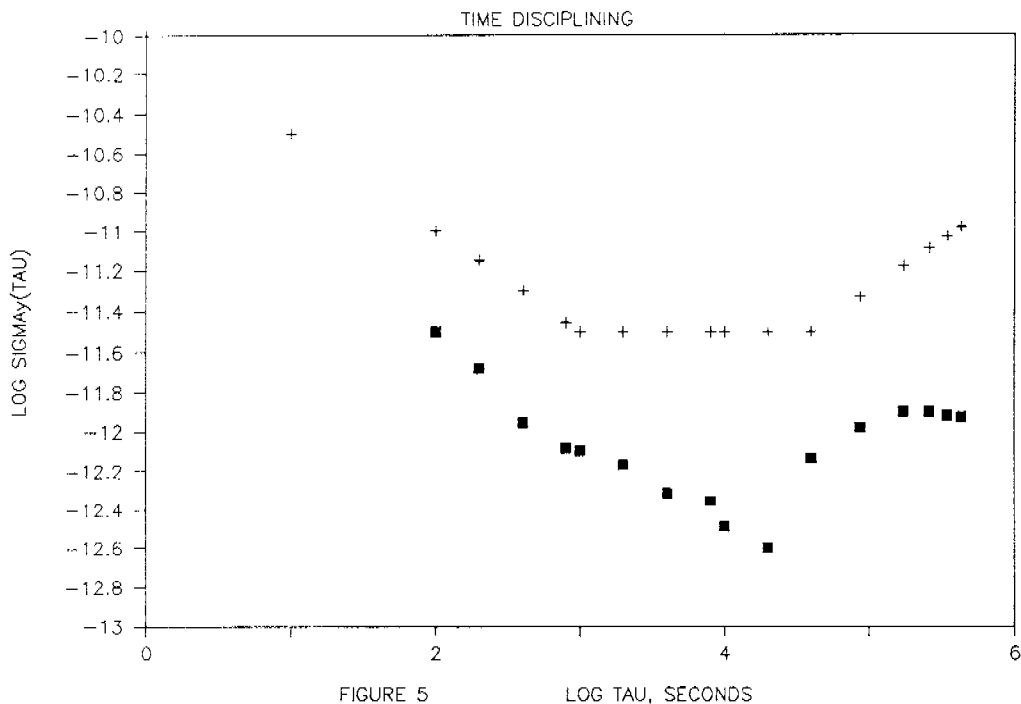
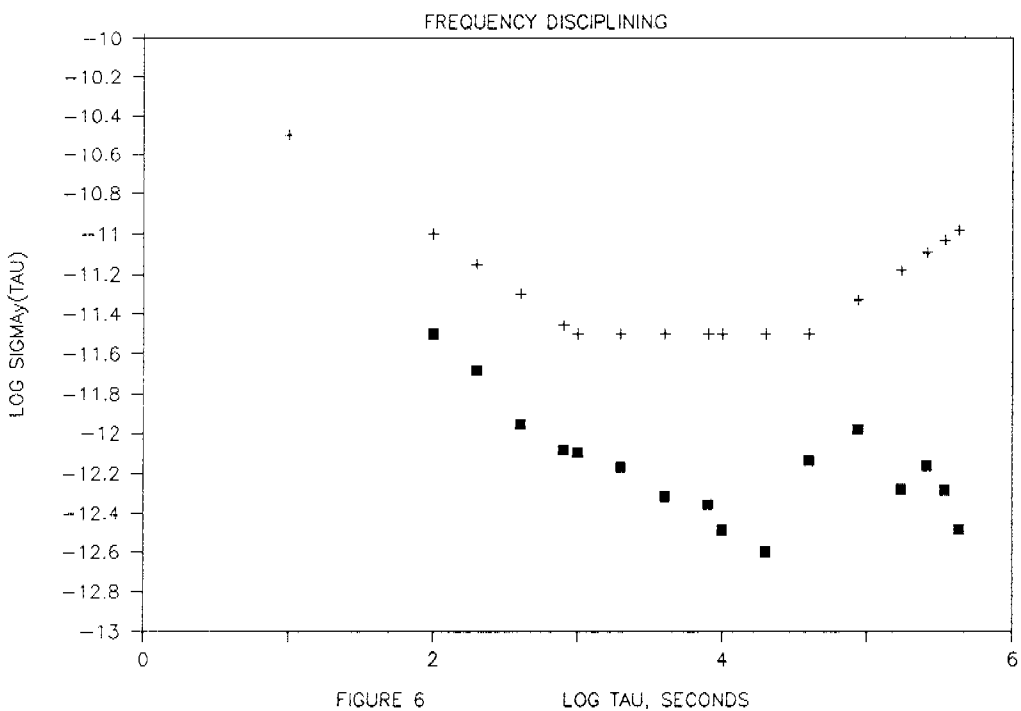

FIGURE 4

DISCIPLINED RUBIDIUM VS Cs AND GPS



DISCIPLINED RUBIDIUM VS Cs AND GPS



FREQUENCY COMPARISON, Rb VS GPS

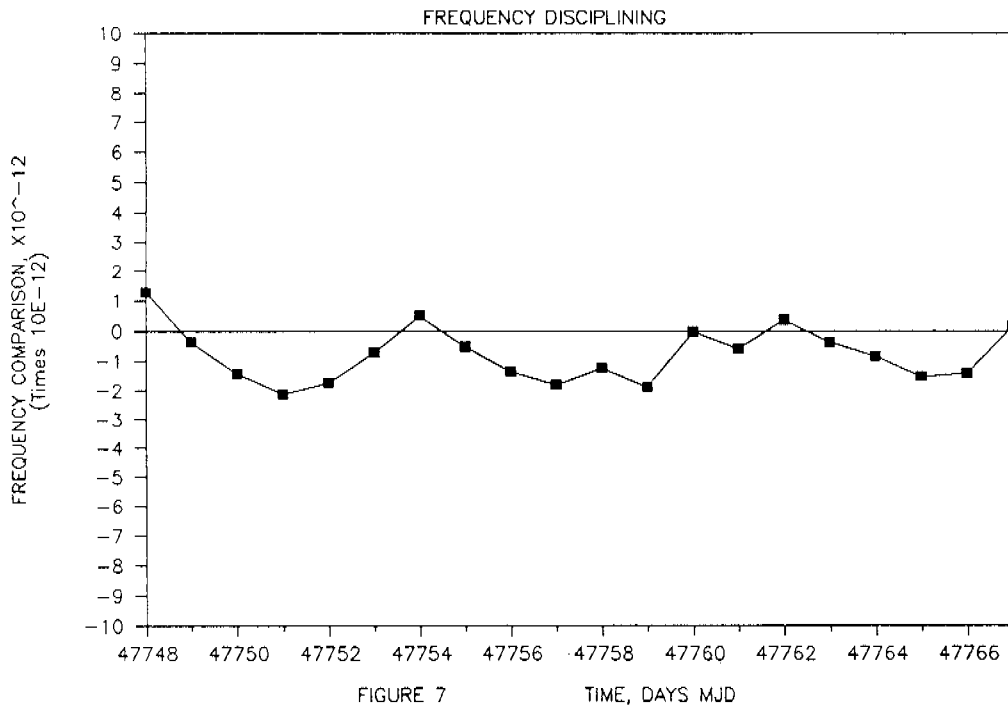

FREQUENCY COMPARISON, Rb VS Cs

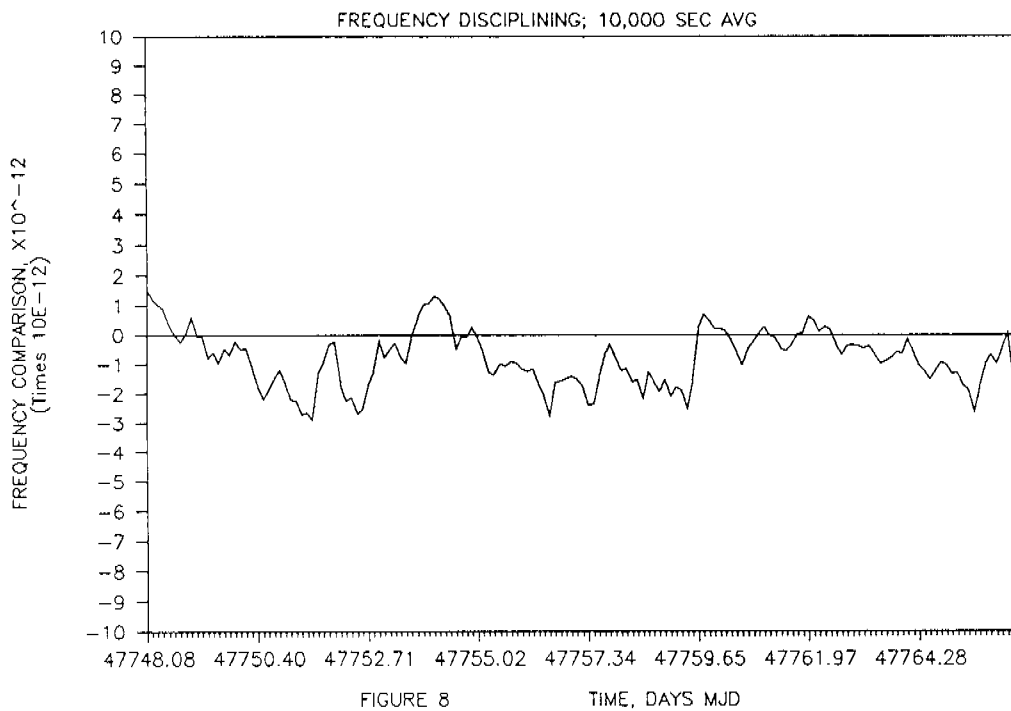

DAILY PEAK TIME ERROR TO GPS RECEIVER

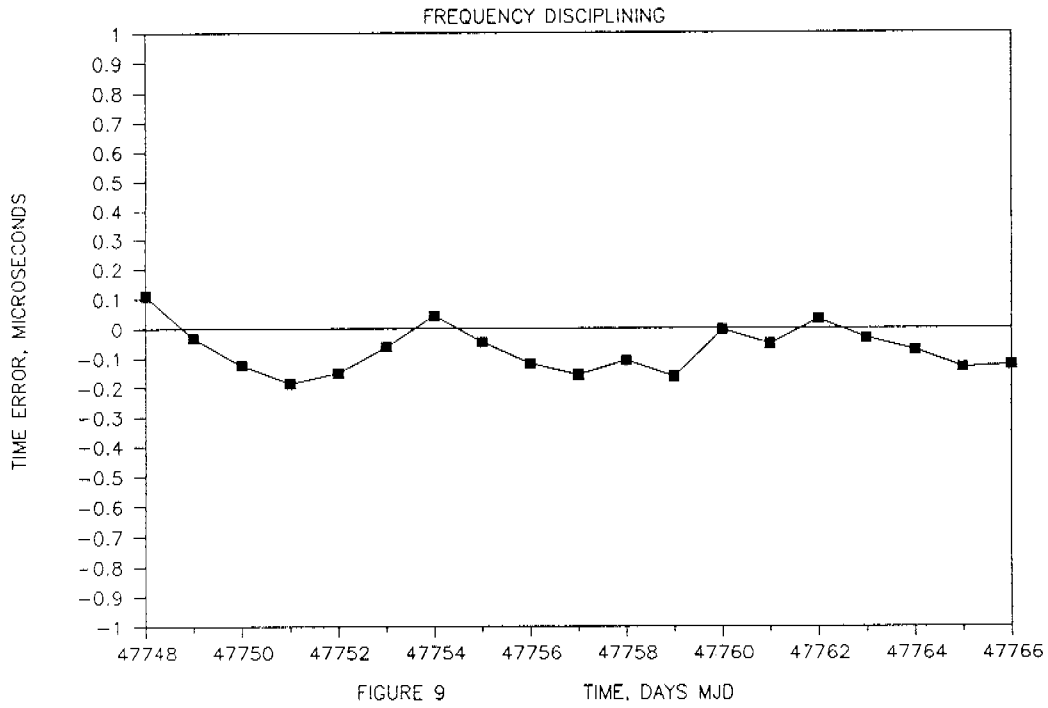

FIGURE 9

FREQUENCY COMPARISON, Rb VS GPS

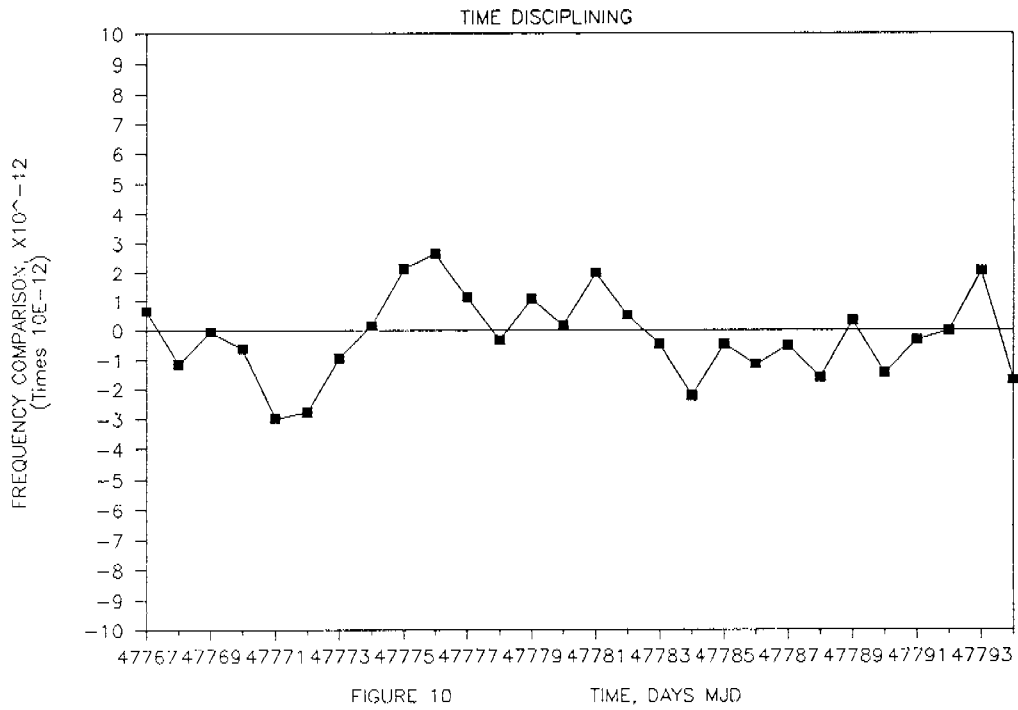

FIGURE 10

RUBIDIUM DAILY PEAK TIME ERROR TO GPS

